

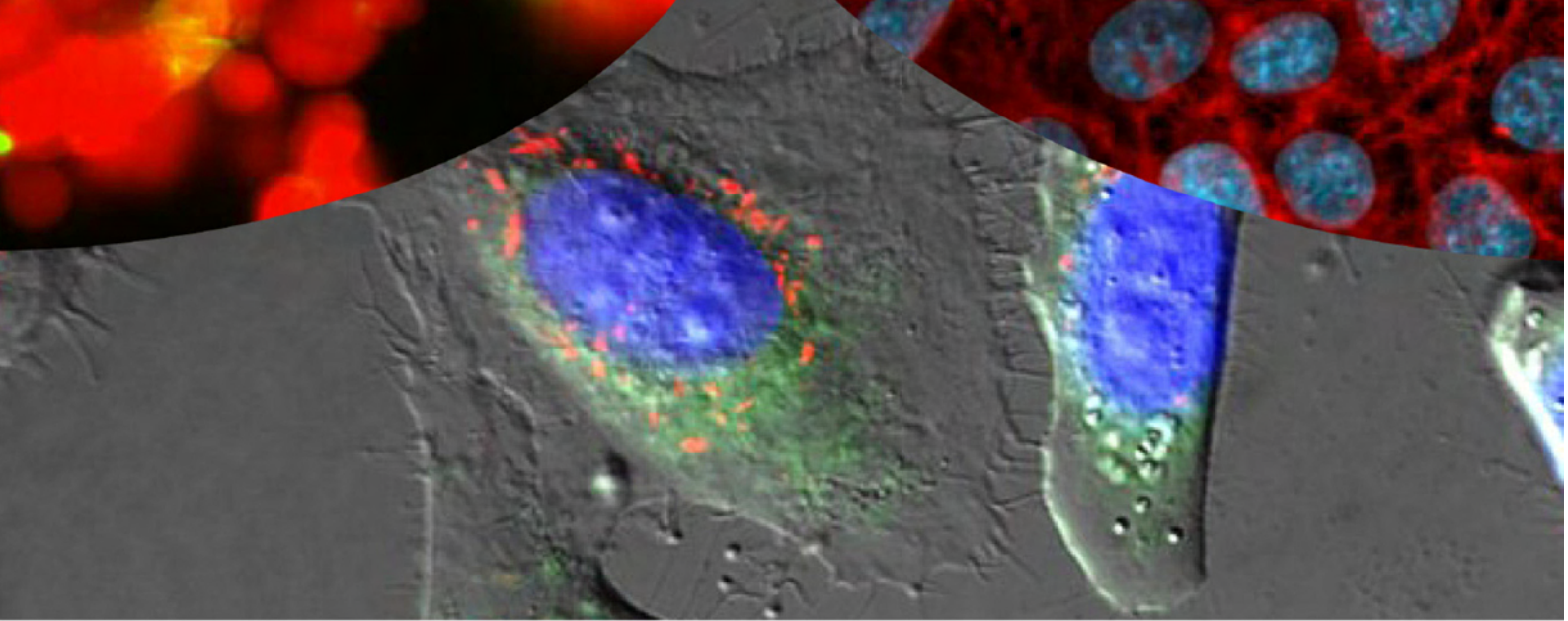

**Mo Bi Tec**  
MOLECULAR BIOTECHNOLOGY

**Scientific Labware**  
**for cell based imaging, assays & arrays**

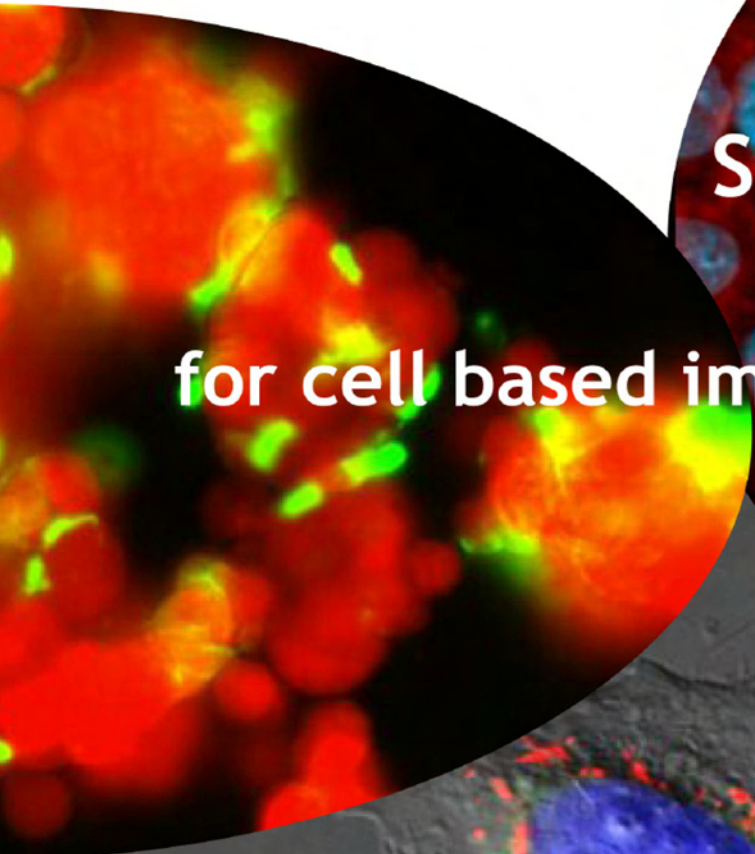

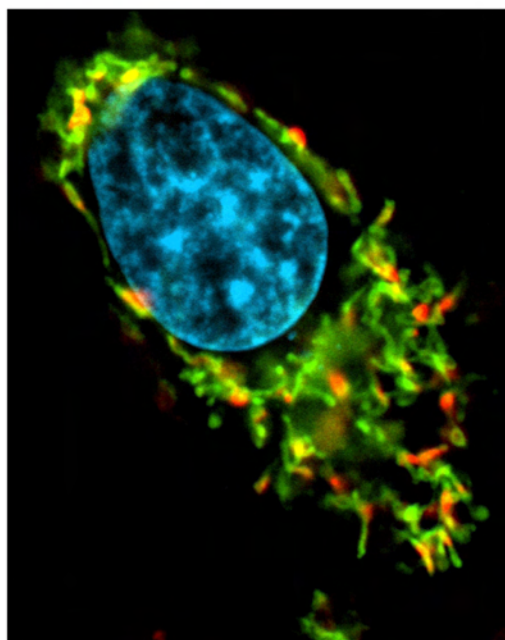

**Imaging Dish CG** ..... 3

**Imaging Plate CG** ..... 4

**Imaging Plate FC**..... 5

**FAQ**..... 6

**Tips & Tricks** ..... 7

**Imaging Chambers and Imaging Chambers CG** ..... 8

**Slide Tray Plate (PS and PP)**..... 9

**UV Plate** ..... 10

**ImmunoSelect® Adhesion Slides**..... 11

**Product drawings and dimensions**..... 12 - 14

**Material guide** ..... 15

**new products**

**Slide Tray PS TC**

In addition to our Slide Tray Plate PS we introduced a TC variant (Tissue Culture treated). Therefore, these products can now be used for direct cell culture and microscopy applications. Due to our proprietary plasma processes the surface is highly aminated to strongly promote cell adhesion and spreading.

**Imaging Dish CG**

These Petri dishes with a 35 mm outer diameter provide a central core of 18 mm with a cover glass bottom made from high quality borosilicate glass. The glass plane of the dish is about 2 mm lower compared to the plane of the surrounding polystyrene housing. Therefore, it is easy to concentrate the distribution of your cells on the glass surface. The surface treatment is known from our Imaging Plate CG products and provide an excellent Tissue Culture surface. Cover glass bottoms of 145 µm and 175 µm (± 15 µm) can be chosen. The dishes have macroscopic marks for orientation and a third product variant is offered with a µGrid on the glass for microscopic orientation.

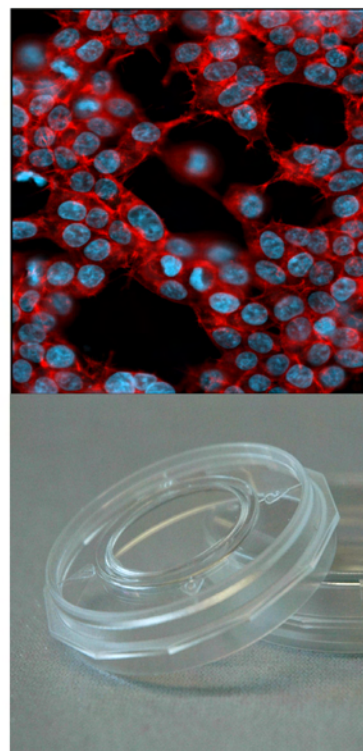



## Imaging Dish CG (cover glass)

### Application

- Laser scanning confocal microscopy
- Total internal reflection fluorescence
- Differential interference contrast
- Fluorescence correlation spectroscopy
- Low intensity fluorescence

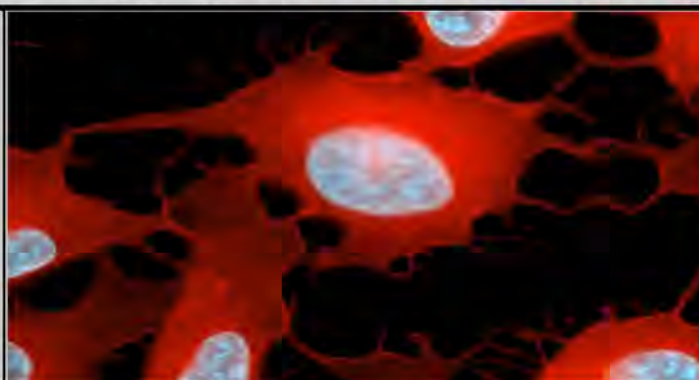

### Features of cover glass bottom

- Borosilicate glass bottom, 145  $\mu\text{m}$  or 175  $\mu\text{m}$  thickness
- Excellent well planarity
- Tissue Culture surface to support cell spreading and adhesion
- Optical benefits of borosilicate cover glass

### Cover glass bottom with advanced cell culture surface properties

- Amino group surface treatment for better cell adhesion, distribution and spreading
- High quality cover glass as gold standard for imaging applications

35 mm polystyrene (PS) dish with central cover glass area (diameter 18 mm), glass level is 2 mm below PS dish basement. N-W-S-O marks for better ROI orientation. Variants with cover glass no. 1.0 and 1.5.  $\mu\text{Grid}$  version for improved ROI relocation or cell migration observation.

Imaging Dishes CG are suited to be used between -20 °C and 50 °C.

Use of alcohols or ketones has to be tested to avoid weakening of the adhesive.

Dish diameter	35 mm	Distance dish bottom / Imaging area	400 $\mu\text{m}$
Imaging area / diameter	18 mm	Surface treatment	TC
Total volume	7 ml	Lid	yes
Suggested cell seeding volume	750 $\mu\text{l}$	Sterile	yes
Suggested working volume	2 ml	Planarity / Flatness	$\leq 5 \mu\text{m}$
<b>Article number</b>	<b><math>\mu\text{Grid}</math></b>	<b>Glass No.</b>	<b>Thickness</b>
5160-30	no	1.0	145 $\mu\text{m}$
5160-168	no	1.0	145 $\mu\text{m}$
6160-30	no	1.5	175 $\mu\text{m}$
6160-168	no	1.5	175 $\mu\text{m}$
7160-30	0.3 x 0.3 mm	1.5	175 $\mu\text{m}$
7160-168	0.3 x 0.3 mm	1.5	175 $\mu\text{m}$
			<b>Packaging format</b>
			6/bag, 30/box
			6/bag, 168/box
			6/bag, 30/box
			6/bag, 168/box
			6/bag, 30/box
			6/bag, 168/box

## Imaging Plate CG (cover glass)

### Application

- Laser scanning confocal microscopy
- Total internal reflection fluorescence
- Differential interference contrast
- Fluorescence correlation spectroscopy
- Low intensity fluorescence dyes

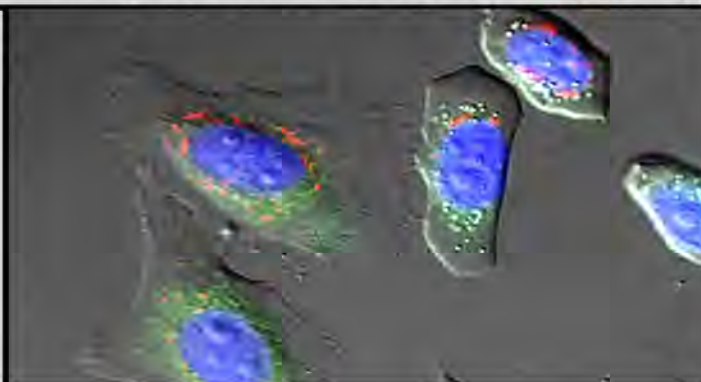

### Features of cover glass bottom

- Borosilicate glass bottom, 145  $\mu\text{m}$  thickness
- Excellent plate and well planarity
- Tissue Culture surface to support cell spreading and adhesion
- Optical benefits of cover glass

### Cover glass bottom with advanced cell culture surface properties

- Amino group surface treatment for better cell adhesion, distribution and spreading
- High quality cover glass as gold standard for imaging applications

The 96 well version is designed as low profile plate and supports the use of immersion objectives for the entire plate.

Imaging plates CG are suited to be used between  $-20\text{ }^{\circ}\text{C}$  and  $50\text{ }^{\circ}\text{C}$ .

Use of alcohols or ketones has to be tested to avoid weakening of the adhesive.

	24 well	96 well
Article number	5231-20	5241-20
Inner well diameter (imaging plane)	13.2 mm	6 mm
Total well volume	1880 $\mu\text{l}$	428 $\mu\text{l}$
Suggested working volume	500 - 1000 $\mu\text{l}$	100 - 200 $\mu\text{l}$
Distance plate bottom to imaging plane	2.5 mm	400 $\mu\text{m}$
Inner well flatness	$\leq 10\text{ }\mu\text{m}$	$\leq 10\text{ }\mu\text{m}$
Well to well flatness	$\leq 50\text{ }\mu\text{m}$	$\leq 50\text{ }\mu\text{m}$
Surface treatment	TC	TC
Lid	yes	yes
Sterile	yes	yes
Packaging format	1/bag, 20/box	1/bag, 20/box



## Imaging Plate FC (fluorocarbon)

### Application

- Live cell imaging
- Metabolically highly active cells
- High content screening
- Laser scanning confocal microscopy
- Low intensity fluorescence dyes

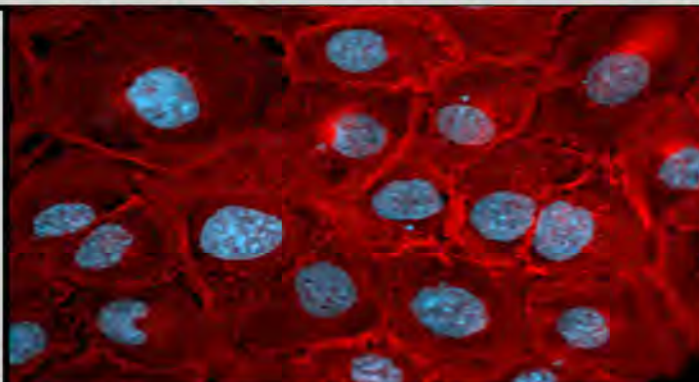

### Features of fluorocarbon film bottom

- Gas permeable
- Excellent light transmission
- Low intrinsic fluorescence
- Excellent plate and well planarity
- Glass-like optics, polymer-like cell growth

### Fluorocarbon film bottom for unique combination of an advanced cell culture model and imaging properties

- Amino group surface treatment for better cell adhesion, distribution and spreading
- Film bottom can be cut and transferred for SEM, TEM or upright microscopy
- Thin film bottom (25  $\mu\text{m}$  thickness) supports high resolution imaging

The 96 well version is designed as low profile plate and supports the use of immersion objectives for the entire plate.

Imaging plates FC are suited to be used between -20  $^{\circ}\text{C}$  and 50  $^{\circ}\text{C}$ .

Use of alcohols or ketones has to be tested to avoid weakening of the adhesive.

	24 well	96 well
Article number	3231-20	3241-20
Inner well diameter (imaging plane)	13.2 mm	6 mm
Total well volume	1880 $\mu\text{l}$	428 $\mu\text{l}$
Suggested working volume	500 - 1000 $\mu\text{l}$	100 - 200 $\mu\text{l}$
Distance plate bottom to imaging plane	2.5 mm	400 $\mu\text{m}$
Inner well flatness	$\leq 10 \mu\text{m}$	$\leq 10 \mu\text{m}$
Well to well flatness	$\leq 50 \mu\text{m}$	$\leq 50 \mu\text{m}$
Surface treatment	TC	TC
Lid	yes	yes
Sterile	yes	yes
Packaging format	1/bag, 20/box	1/bag, 20/box





## Frequently Asked Questions

## Imaging Plate FC (Fluorocarbon)

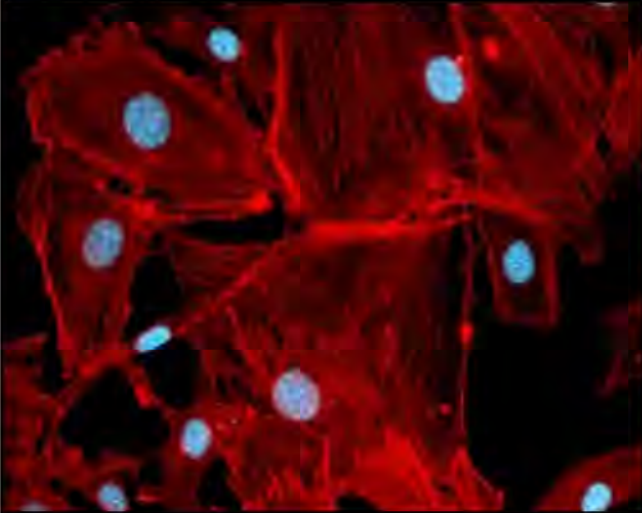

### Technical specification of the fluorocarbon film

- Thickness: 25  $\mu\text{m} \pm 10\%$
- Light transmission:  $>70\%$ @240 nm,  $>90\%$ @300 nm
- Refractive index: 1.34
- Abbe's number:  $>70$
- Oxygen permeability [ $\text{cm}^3 / (\text{m}^2 \cdot \text{d} \cdot \text{bar})$ ]:  $>6300$
- $\text{CO}_2$  permeability [ $\text{cm}^3 / (\text{m}^2 \cdot \text{d} \cdot \text{bar})$ ]:  $>7000$
- Coefficient of thermal conductivity [ $\text{mW} / \text{K}$ ]: 0.01
- Dielectric strength: 240 kV / mm

### Can the thin bottom film of the Imaging Plate FC be perforated by pipette tips?

The fluorocarbon film shows an elongation at break of 300%. Very sharp instruments are usually necessary to puncture the film accidentally or by intention (e.g. metal canulas, scalpel knives). Nevertheless, strong forces and touching of the bottom by pipette tips should be avoided (deformation, scratches, shearing film from plate bottom).

### Can the Imaging Plate FC be used in a centrifuge?

Though the adhesive used to bond the film and plate bottom withstands mild centrifugation forces, if the bottom is mechanically supported, it is generally not recommended to use the plate in a centrifuge.

### Which immersion media can be used?

All general types of immersion media (oil, glycerine, water) can be used.

### How long can the Imaging Plate FC be incubated?

Batch release incubation tests are performed for 14 days. Longer incubation should be possible without harm.

### I have problems with focusing. What can be done?

The bottom of the plates is only 25  $\mu\text{m}$  thick. Please make sure that you use objectives (important for 40x magnification and higher) which can be adjusted to this bottom thickness or are corrected for 170  $\mu\text{m}$  or thinner cover glass. A known incompatibility exists with the InCell Analyzer 3000 (it's autofocus system needs a bottom of minimal 600  $\mu\text{m}$ ). Other systems are fully compatible (e.g. InCell Analyzer 1000) and give you the full benefit of optical properties of the plates.

### Which methods and chemicals can be used for fixation and permeabilization in the plates?

The polystyrene (PS) body of the plates is the limiting factor in the selection of chemicals (see chemical compatibility charts for PS). The fluorocarbon bottoms withstands all generally applied chemicals and fixation, permeabilization or embedding procedures. Upper temperature limits for the integrity of the plates are 50  $^{\circ}\text{C}$ . Lower temperature limits are -80  $^{\circ}\text{C}$ .



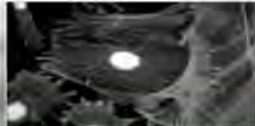

## Tips & Tricks

## Imaging Plate FC (Fluorocarbon)

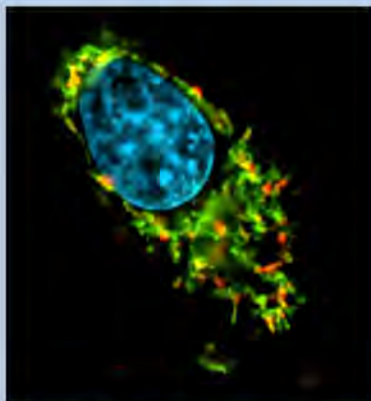

UV-A and UV-B light transmission

The properties of the fluorocarbon film bottom allow, beside imaging and physiological cell growth, some special applications. Among these special features are:

- Transparency for UV-A and UV-B
- High gas transfer
- The film bottom can be cut and cells transferred for other examination procedures
- The thin film bottom and its refractive index enable the use of water dipping objectives

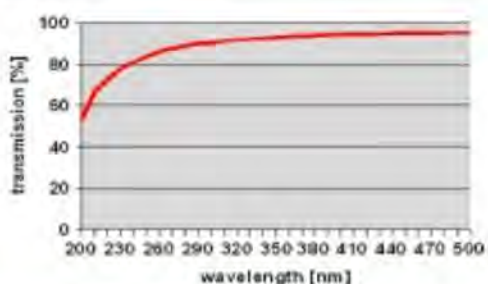

The film bottom of the plates is transparent to UV-A and UV-B light.

Experimental investigation of cell responses to short wavelength light is possible by irradiating the cells through the plate bottom. This enables equal and well controlled experimental conditions to study photo effects.

### Gas transfer through the plate bottom

The thin fluorocarbon film bottom enables high gas transfer rates between the cellular microenvironment and the surrounding incubator. Therefore, unique control over gas partial pressure in the cellular microenvironment is possible. Metabolically highly active cells can get the required oxygen without limitation. A rapid and homogenous adaptation of gas partial pressure for hypoxia experiments in prepared incubators is also enabled.

### Cutting the film bottom

Especially the 24 well version is suited to get access to the cultivated cell layers. The film bottom can be easily cut with a scalpel and transferred for further applications, e.g. ultrathin and semithin cross section for TEM or light microscopy. Another frequent application is the transfer to a glass microscope slide. Let the film flatten on the slide by aid of a droplet of ethanol. Afterwards, it can be covered by conventional techniques with a cover glass (for upright microscopy or archiving of the sample).



### Water dipping objectives

Perfect resolution and quantum yield can be obtained if water dipping objectives with high numerical apertures are used for inverse microscopy. With no other product combination you get as close to the cells with equivalent quantum yield.



## Imaging Chambers and Imaging Chambers CG

### Application

- Laser scanning confocal microscopy
- Total internal reflection fluorescence
- Differential interference contrast
- Fluorescence correlation spectroscopy
- Fluorescence resonance energy transfer
- Fluorescence recovery after photobleaching
- Low intensity fluorescence
- Fluorescence in situ hybridization
- Immunohistology



### Features

- Extraordinary planarity of the imaging plane, even during temperatures shifts
- High temperature stability, suitable for FISH
- High chemical resistance, fixation with acetone possible
- Bottom glasses can be obtained with minimal glue residues
- All Imaging Chambers are delivered with lid and on a Slide Tray Plate

### Available with microscope slides or cover glass as bottom structure

- Made from high performance polymers and sealed to the glass bottoms by biological inert silicone adhesive. At the end of the experiments the glasses can be detached from the polymer chambers with minimal glue residue.
- High performance polymer of chamber bodies and lids withstands temperatures up to 90 °C and is resistant to acetone. All products are suitable for *in situ* hybridization technologies as well as for a wide range of fixation and staining protocols.
- Designed for high resolution live cell microscopy. Imaging Chambers with microscope slides can be used with long distance objectives. After disassembly the slides can be covered with cover glasses and are then also suitable for high resolution immersion microscopy.
- Cell adhesion, spreading and distribution on top of the glass surface is improved due to our proprietary plasma surface modifications.

	Cover glass slide properties		Microscope slide properties	
<b>Thickness</b>	170 µm +/- 10%		1 mm	
<b>Glass type</b>	Borosilicate glass, hydrolytic class I		Soda lime, smoothed corners, frosted ends	
<b>Article number</b>	<b>8011-16</b>	<b>8012-16</b>	<b>8014-16</b>	<b>8018-16</b>
	<b>8011-80</b>	<b>8012-80</b>	<b>8014-80</b>	<b>8018-80</b>
	<b>8001-16 (CG)</b>	<b>8002-16 (CG)</b>	<b>8004-16 (CG)</b>	<b>8008-16 (CG)</b>
	<b>8001-80 (CG)</b>	<b>8002-80 (CG)</b>	<b>8004-80 (CG)</b>	<b>8008-80 (CG)</b>
Number of wells / chamber	1	2	4	8
Chamber height	10 mm	10 mm	10 mm	10 mm
Imaging area / well	10.84 cm <sup>2</sup>	5.04 cm <sup>2</sup>	2.14 cm <sup>2</sup>	0.88 cm <sup>2</sup>
Total volume / well	11 ml	5.5 ml	2.2 ml	0.9 ml
Suggested working volume/well	2000 µl	1000 µl	500 µl	300 µl
Total chamber length	58 mm	58 mm	58 mm	58 mm
Total chamber width	26 mm	26 mm	26 mm	26 mm
Refractive index	1.52	1.52	1.52	1.52
Abbe's number	50	50	50	50
Packaging format	16 / box or 80 / box			



## Slide Tray Plate

### Application

- Horizontal handling of microscope slides
- Horizontal handling of microarray slides
- Staining / storage / incubation of slides
- Transport and handling of chambered slides and slide flasks



### Features of Slide Tray Plates

- Handling of up to four slides
- Easy access zone for slide removal
- Optimized for stacking
- Transparent PS or chemical resistant PP
- SBS plate footprint

### Handling of microscopy and array slides made easy

- Polystyrene plates for sterile cell culture applications and microscopy (Tissue Culture and bacterial grade)
- Polypropylene plates for storage / staining applications, chemical resistance
- Colorants or surface treatments on request
- Easily stackable, easy grip

	Polystyrene	Polypropylene
Article number	1145-40 1245-40 (TC)	1345-40
Single chamber width / length	28 mm / 78 mm	28 mm / 78 mm
Single chamber height	7.3 mm	7.3 mm
Suggested working volume / chamber	3000 µl	3000 µl
Total plate length	127.5 mm	127.5 mm
Total plate width	86 mm	86 mm
Plate height	11.3 mm	11.3 mm
Surface treatment	no treatment	no treatment
Lid	yes	yes
Sterile	yes	no
Packaging format	10/bag, 40/box	10/bag, 40/box



## UV Plate

### Application

- OD measurement, UV-A and UV-B
- Direct DNA and RNA measurement
- DNA purity
- Small molecule detection

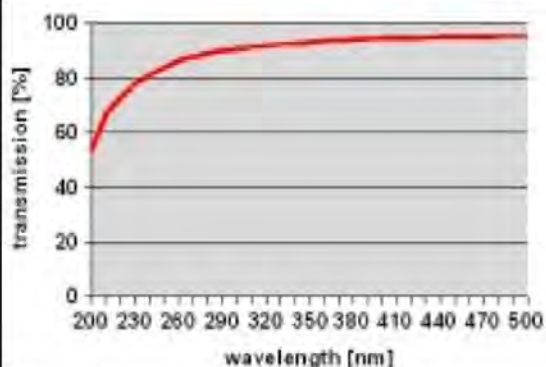

### Features of UV Plates

- Excellent UV-light transmission
- Convenient package size
- RNA / DNA free
- RNase / DNase free

### UV-light transparent film bottom for OD detection

- Transparent plate body
- 25  $\mu\text{m}$  thin UV-transparent film bottom
- Superior transparency and homogeneity
- Stacks of 10 plates, no lid, not sterilized

	96 well
Article number	2145-40
Inner well diameter (imaging plane)	6 mm
Total well volume	428 $\mu\text{l}$
Suggested working volume	50 - 350 $\mu\text{l}$
Surface treatment	hydrophilic
Lid	no
Sterile	no
Packaging format	10/bag, 40/box



## ImmunoSelect® Adhesion Slides

### Application

- Immunofluorescence methods
- Immunoenzymatic tests
- Histological staining techniques
- Intracellular antigen evidencing
- Molecula biological tests



### Features

- Very fast adhesion of cells and tissue sections with high retainment >95% !
- New alternative to Polylysine and other adhesion techniques
- No cytopins or smears necessary, simply drop the cells and let them float down
- Cell adhesion resistant to heating, staining and denaturation procedures
- No cell loss even at harsh cytological staining procedures
- Superb retainment of cell and tissue morphology

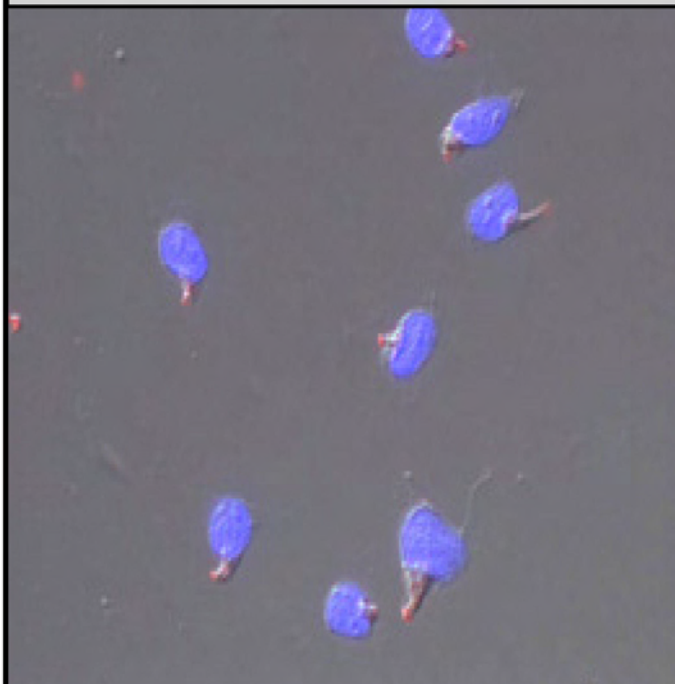

### For optimum cell retainment and morphology

- Developed for microscopical use, where precious and only poorly available cellular material should be efficiently immobilized.
- Stop cell loss even at harsh incubation procedures in contrast to commonly coated slides.
- ImmunoSelect® adhesion surface allows a fast and highly efficient immobilization of the cells and helps to reduce cellular material and reagents.
- Extremely fast binding of the cellular material to the glass surface saves time consuming centrifugation and drying procedures.
- Square Linque® surface combines different binding principles to natural surface structures of cells and tissues and anchored them securely to the glass surface. Due to this procedure the cells do not lose their antigenicity or ability to function.

Article number	Description	Packaging format
SQ-IS-10050	ImmunoSelect® Adhesion Slides	50 pcs
SQ-IS-10100	ImmunoSelect® Adhesion Slides	100 pcs



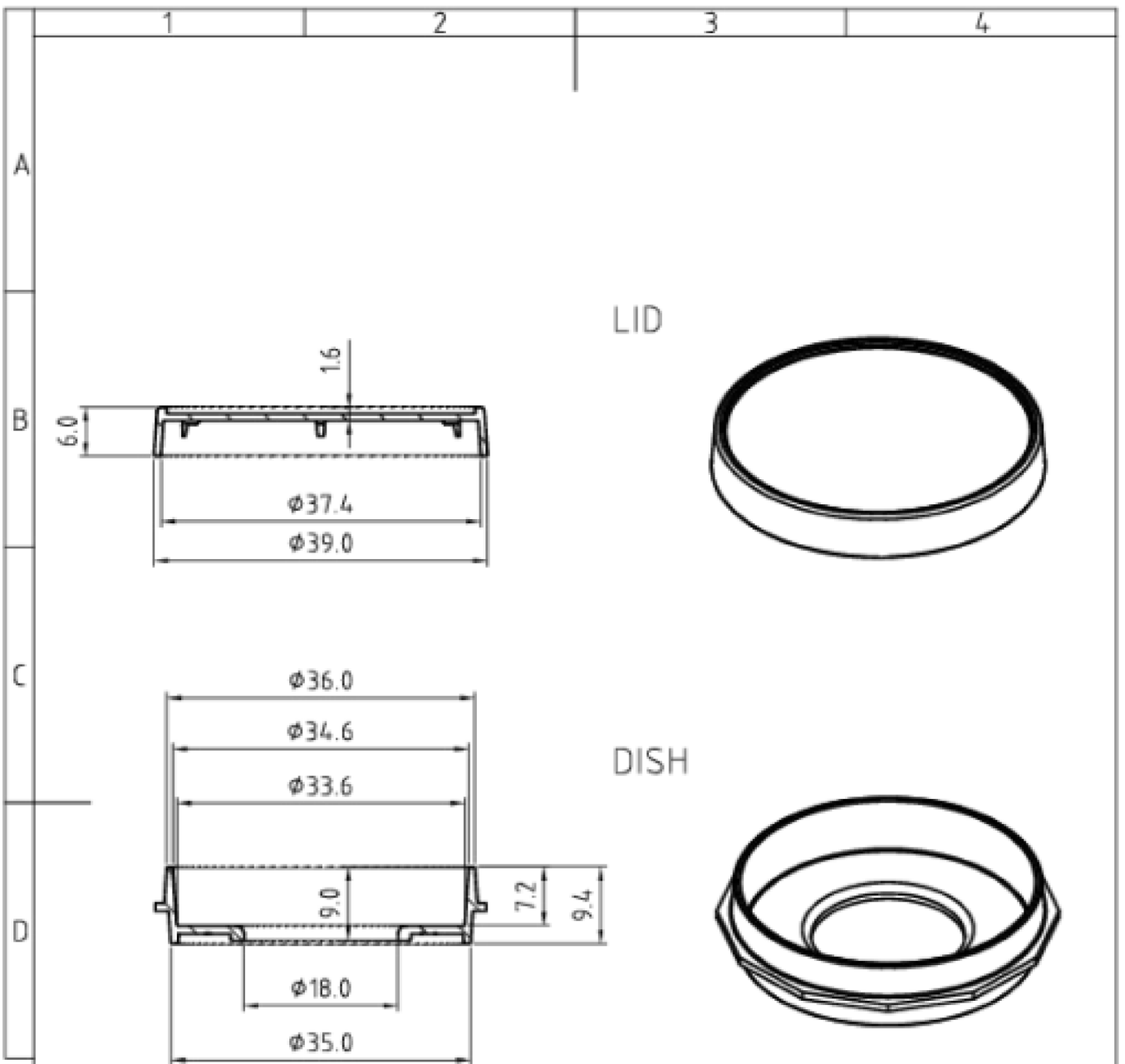

		Maßstab 1:1		Plat-Datum 15.12.08			
		<b>Imaging Dish</b>					
	Datum					Name	
Bearb.	15.12.2008						
Zeichn.							
		Blatt					
		Bl					

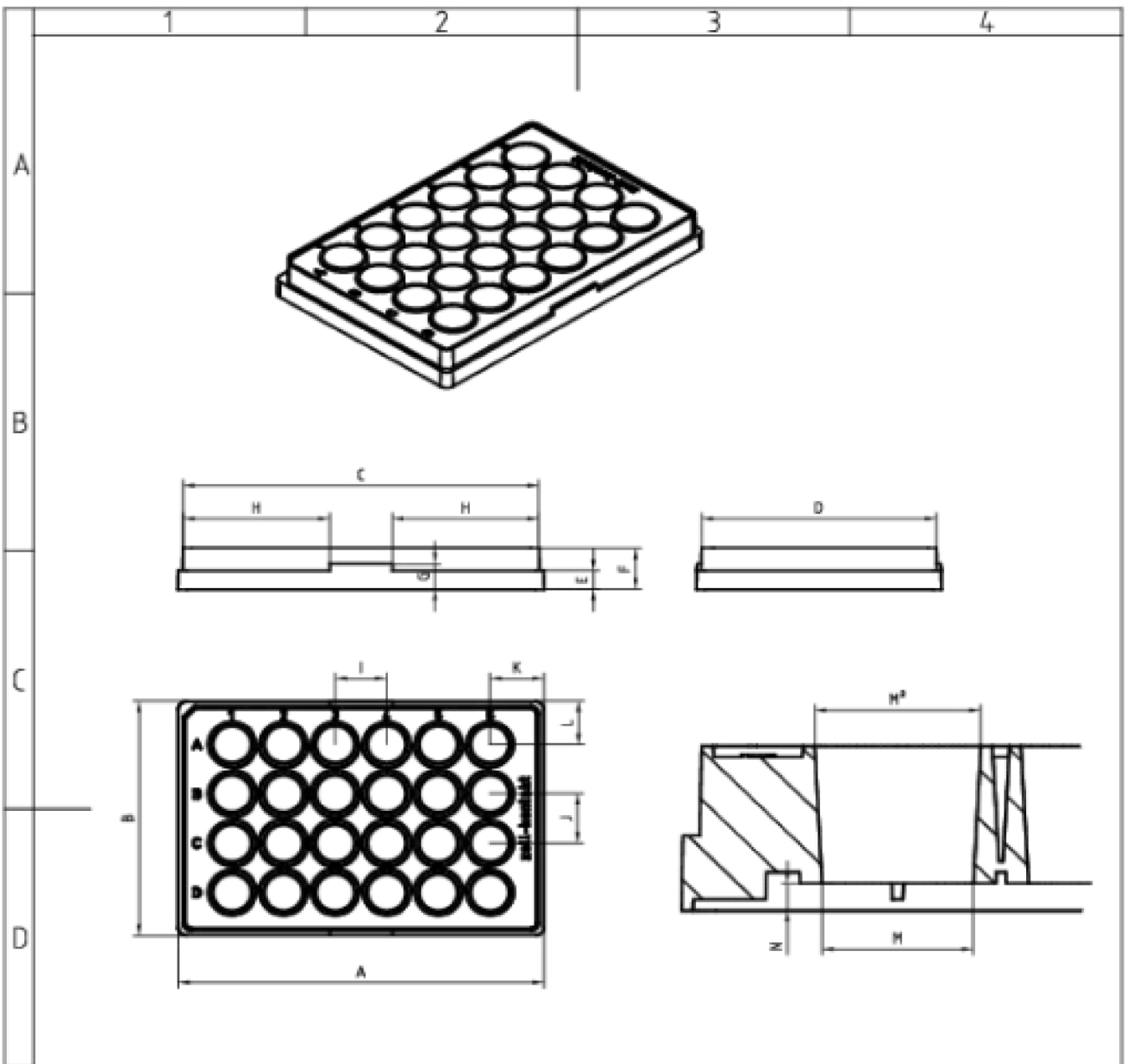

	A	B	C	D	E	F	G	H	I	J	K	L	M	M <sup>2</sup>	N
MM	127.16	85.48	124.2	82.0	6.8	15.0	9.3	51.2	18.0	18.0	18.88	15.74	∅13.2	∅14.5	2.5
INCH	5.030	3.365	4.890	3.228	0.268	0.591	0.366	2.016	0.709	0.709	0.743	0.620	∅0.520	∅0.571	0.098

				Maßstab	1:2	Plat-Datum	20.9.07	
				Werkstoff: PS		Masse: 39,3 g Volumen: 37,5 cm <sup>3</sup>		
				<b>Imaging Plate 24, plate body</b>				
								Blatt
								Bl



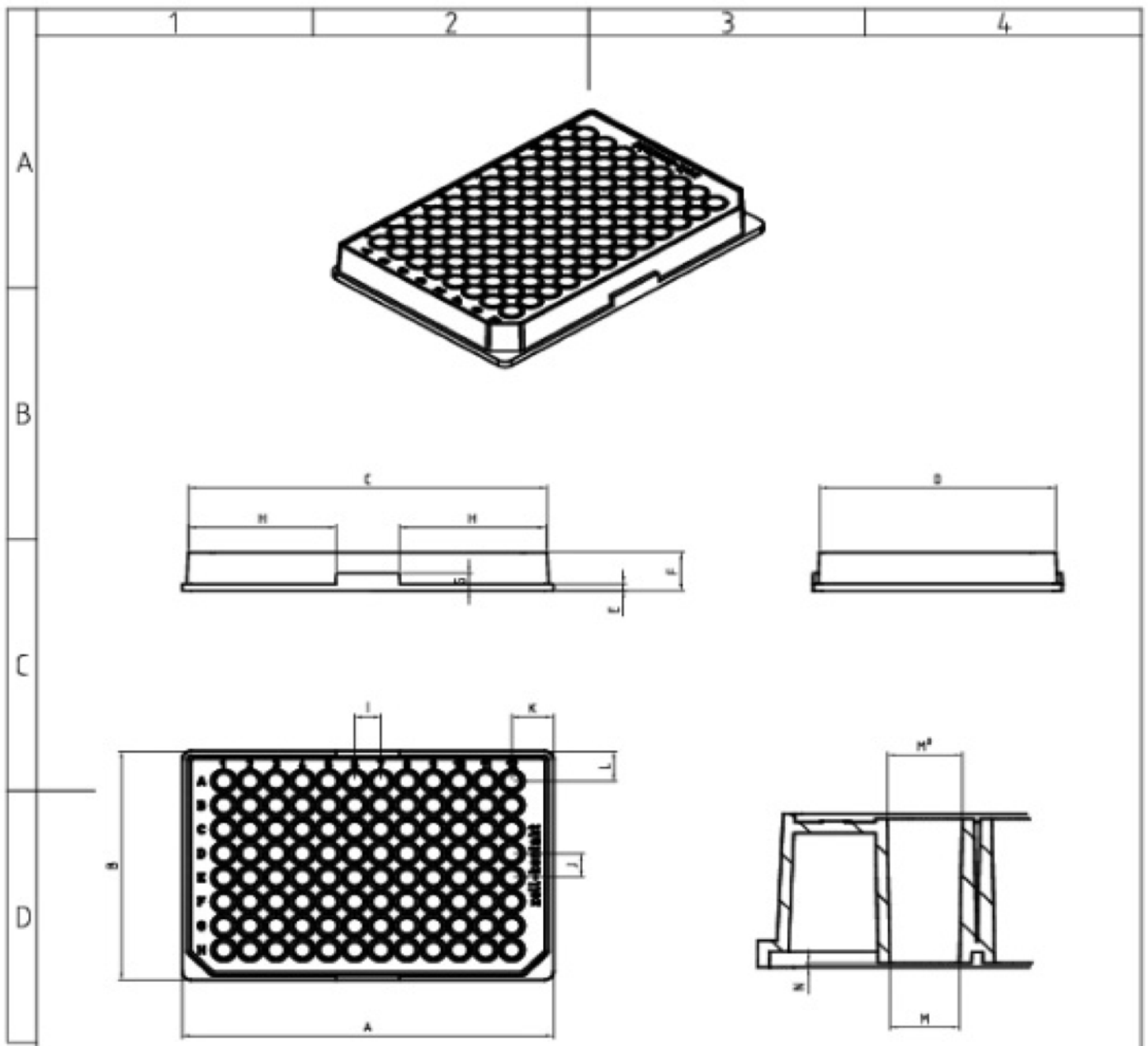

	A	B	C	D	E	F	G	H	I	J	K	L	M	M <sup>2</sup>	N
MM	127.76	85.48	123.3	81.2	2.5	14.35	6.5	50.3	9.0	9.0	14.38	11.24	∅6.0	∅6.5	0.4
INCH	5.030	3.365	4.854	3.197	0.098	0.565	0.256	1.98	0.354	0.354	0.566	0.443	∅0.236	∅0.256	0.016

		Maßstab 1:2		Plat-Datum 26.02.07		
		Werkstoff: PS		Masse: 49,4g Volumen: 47cm <sup>3</sup>		
		Datum		Name		
		earb. 26.02.2007				
		'epr.				
		orm				
		<b>Imaging Plate 96, plate body</b>				Blaß
						Bl

The materials for our products are carefully selected to provide their specific benefits for the different applications.

**Cover glass:** Excellent chemical resistance, clear and pure borosilicate glass. Hydrolytic class I. Low alkali content (superior cell culture quality). Refractive index: 1.52, Abbe's number: 55.

**Fluorocarbon film:** Excellent chemical resistance, highest light transmission (also in the UV-B spectrum), highly gas permeable. Refractive index: 1.34, Abbe's number: 70.

**Polystyrene:** Average chemical resistance (alcohols, formaldehyde, short term DMSO). Refractive index: 1.59, Abbe's number: 29.

Important for your fluorescence image quality is the Point Spread Function of the complete optical system. Please make sure to use appropriate cover glass correction and objectives to get the high end results which you expect.

Product drawings and detailed information can be found on [www.mobitec.com](http://www.mobitec.com)



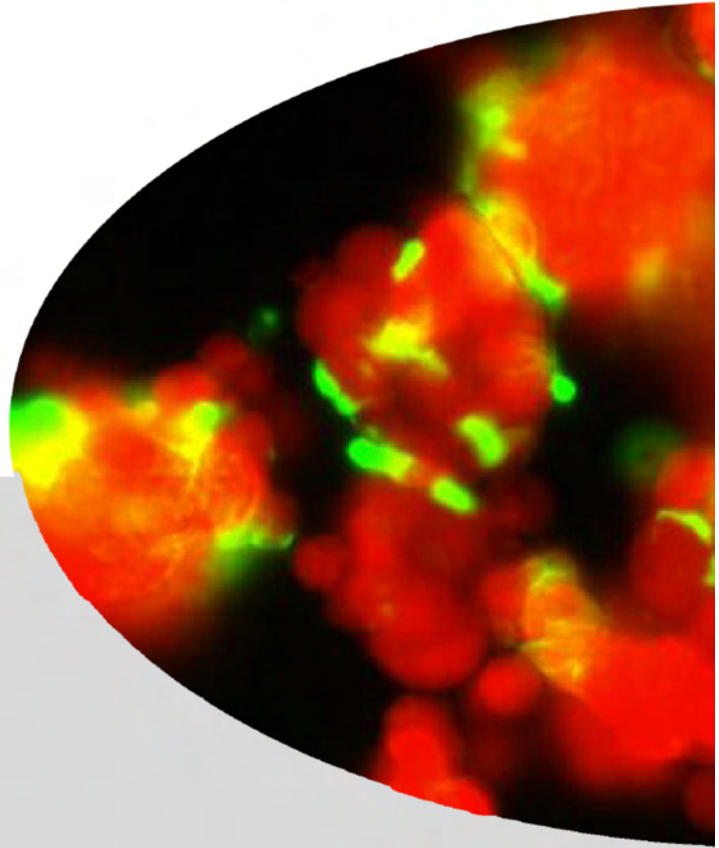

**ImmTec**  
DIAGNOSTICS NV



**Mo Bi Tec**  
MOLECULAR BIOTECHNOLOGY